



## DESCRIPTION, EQUIPMENT AND TECHNICAL FEATURES RSP SUCTION EXCAVATOR



**ESE 4**

RS 4000



**ESE 6**

RD 8000

**ESE 6**

RT 10000





## VARIANT

Fans of different output capacities and transport vehicles of different sizes offer a multitude of combinations to suit any application. Whether a small and extremely manoeuvrable or a large and powerful machine: when operating in sensitive areas, our suction systems are practically unbeatable in terms of non-destructive operation.

CODE	VARIANT	DESIGNATION
------	---------	-------------

180

ESE 4

RSP suction superstructure on a two-axle-chassis. It has been specifically developed for use in narrow inner-city areas. The overall machine width of 2.30 m permits problem-free driving through narrow streets. The collection chamber holds 4 m<sup>3</sup>. The engine's power is sufficient for a single fan.



260

ESE 6

RSP suction superstructure on a 3-axle-chassis. Its compact design and performance capabilities allow the ESE 6 to be used everywhere. The collection tank holds either 6 m<sup>3</sup> or 8 m<sup>3</sup>. Single or twin fans and all types of suction hose carriers can be installed.



320

ESE 6

RSP suction superstructure on a 4-axle-chassis. The optimal balance between size, power and container volume make this machine the all-round specialist. The collection tank holds either 8 m<sup>3</sup> or 10 m<sup>3</sup>. All types of fan speeds and suction hose carriers can be installed.



## SUCTION PERFORMANCES

Fans are the core elements of suction excavators. Their connection and start-up conditions as well as the balance quality and thus their smooth running have a considerable influence on the suction excavators' service life intervals. All RSP fans are balanced to the highest precision standards and smoothly started via hydraulic oil clutches.



CODE	TYPE	VARIANT
A00	ESE 4 ESE 6	High-performance single fan

### DESIGNATION

$Q_{max} = 32,000 \text{ m}^3 / \text{h}^*$ ,  $P_{max} = 21,000 \text{ Pa}^*$

Shaft power = 140 KW

Necessary chassis engine power: 260 KW

Suction distances: in vertical direction up to 15 m\*\*, in horizontal direction up to 70 m\*\*.

Optimal blower for operations in the area immediately around the machine, special bearing for high-speed operations, special steel highly wear resistant impeller blades inclusive of a start-up coupling for a soft start, central lubrication unit for fan bearing and slam shut valve.



A21	ESE 6	High-performance twin fan
-----	-------	------------------------------

$Q_{max} = 42,000 \text{ m}^3 / \text{h}^*$ ,  $P_{max} = 40,000 \text{ Pa}^*$

Shaft power = 200 KW

Necessary chassis engine power: 320 KW

Suction distances: in vertical direction up to 45 m\*\*, in horizontal direction up to 120 m\*\*.

High-performance twin fan for most arduous earth moving work in underground construction and material clean-up operations. A special bearing enables high speeds to be achieved. Special steel highly wear resistant impeller blades, hydraulic start-up coupling for a soft start, central lubrication unit for the fan bearing, slam shut valve.

(\*) Specifications are fan values not plant values

(\*\*) depending on the absorbent material and fan power

## SUCTION PERFORMANCES

This soft start where the rpm is controlled by metering air significantly reduces the load on the drive motor. The ability to regulate the suction power of all RSP fans in three capacity levels allows them to be optimally adjusted to meet the task at hand. Power transmission occurs through toothed belts. The bearings carry a significantly reduced load in that the tension forces are much smaller than those of V-belts. The fans are completely encapsulated, start-up coupling and bearings are cooled with filtered outside air.

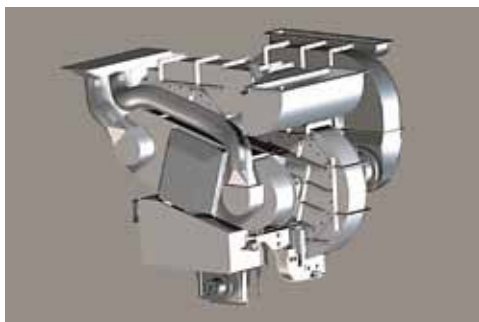

CODE	TYPE	VARIANT	DESIGNATION
A30	ESE 6	Ultra high performance triple fan	$Q_{max} = 43,000 \text{ m}^3/\text{h}^*$ , $P_{max} = 47,000 \text{ Pa}^*$ Shaft power = 350 KW Necessary chassis engine power: 440 KW Suction distances: in vertical direction up to 50 m**, in horizontal direction up to 150 m**. Ultra high performance triple fan, fit to handle even the most exacting jobs. It consists of a twin fan plus a hydraulically driven single fan that can be cut in.
A40	ESE 6	Ultra high performance quadruple fan	$Q_{max} = 44.000,00 \text{ m}^3/\text{h}^*$ , $P_{max} = 55.000 \text{ Pa}^*$ Shaft power 410 KW Necessary chassis engine power: 460 KW Suction distances: in vertical direction up to 50 m**, in horizontal direction up to 200 m** Ultra high performance quadruple fan, for the most demanding applications and suction operations over long distances. It consists of two twin fans of the same design. The OMSI gear drives the first group of twin fans, the second twin fan group is PTO driven; requires an extended wheelbase.



(\*) Specifications are fan values not plant values

(\*\*) depending on the absorbent material and fan power

## SEPARATION SYSTEM

The redesigned separation chambers provide purification and drying of the air stream. The two-block superfine filter unit having a filter surface area of 128 m<sup>2</sup> ensures optimal cleaning of the used air.

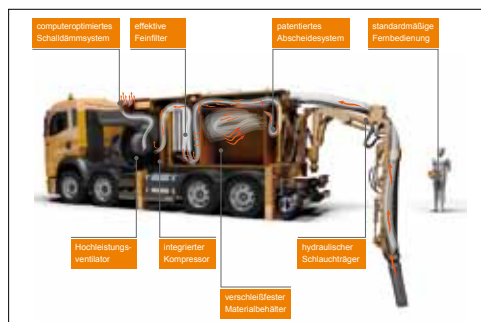

CODE	TYPE	VARIANT	DESIGNATION
B00	ESE 6	RSP separation system	The internationally patented RSP air guidance and separation system guarantees the highest degree of gravity separation, lowest load on the filters and thus consistently high suction performance <sup>1</sup> . Residual dusts that are captured in the filter undergo an intense drying operation. As a result, the fine filters can be effectively cleaned. Collection & separation chamber and the fine-mesh filter unit are emptied whenever a tilting operation is performed.
B01	ESE 4 ESE 6	Fine-mesh filter unit	The cartridge-type (BIA dust class M) fine filter assembly is fitted in the front section of the collecting container. During the tilting operation, the filters are mechanically protected against lateral forces. The residual dust content is <math><10\text{mg}/\text{m}^3</math> and thus in accordance with statutory guidelines. Air pressure is utilized for the automatic filter cleaning system. Short blasts of compressed air from the clean space side make the filter cake drop down for later removal during the tilting operation. The filter unit consists of two baskets which can be individually removed out of the container for cleaning or replacement purposes.



(1) real three-stage separation system

## SEPARATION SYSTEM

The strong container includes the main collecting chamber with a special wear protection, a rear-side separation chamber and the fine filter unit. The discharge takes place by lateral, hydraulic tipping. The tilt angle is bigger than 40 angular grade.

CODE	TYPE	VARIANT	DESIGNATION
B04	ESE 4	Tilting container, 4 m <sup>3</sup> volume	This container size has been specifically developed for two-axle vehicles with an overall width of 2,30 m. The container is very resistant to torsion. The tilting axis height is 2,10 m, and the tipping angle is circa. 40°.
B06	ESE 6	Tilting container, 6 m <sup>3</sup> volume	This container size has been specifically developed for three-axle vehicles incorporating a steered tag axle; thus, the load carrying capacity of the axle is reduced accordingly. The container is very compact and can therefore be mounted onto vehicles with short wheelbases.



## SEPARATION SYSTEM

The RSP suction superstructure has been designed and optimized for specific uses on construction sites. A stainless steel drip edge helps reduce dirt accumulation during the emptying of liquid materials. The containers are built in different sizes to suit the different chassis sizes.



CODE	TYPE	VARIANT	DESIGNATION
B08	ESE 6	Tilting container, 8 m <sup>3</sup> volume	Depending on the nature of the material removed, up to 7 m <sup>3</sup> of the 8 m <sup>3</sup> volume is available for material collection. This is the standard container for three- and four-axle chassis.



B10	ESE 6	Tilting container, 10 m <sup>3</sup> volume	Due to the larger container volume, a better relationship between suction and emptying time is achieved. This container is 15 cm higher than the standard 8 m <sup>3</sup> container. It can only be mounted onto four- or five-axle chassis.
-----	-------	---	---

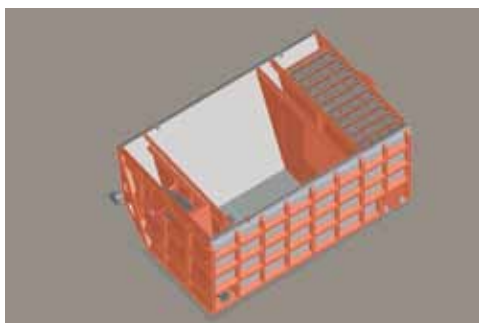

B20	ESE 4 ESE 6	Stainless steel wear plates	The long sides and the bottom of the tilting container are equipped with stainless steel wear plates. We recommend using this equipment if you want to remove aggressive materials. The very smooth surfaces help empty the container completely.
-----	----------------	-----------------------------	---



## SEPARATION SYSTEM

The RSP suction superstructure has been designed and optimized for specific uses on construction sites. A stainless steel drip edge helps reduce dirt accumulation during the emptying of liquid materials. The containers are built in different sizes to suit the different chassis sizes.



CODE	TYPE	VARIANT	DESIGNATION
B21	ESE 4 ESE 6	tipping container stainless steel	All sides of the tipping container including the bottom and the underside of the lid are made of stainless steel. This ensures high corrosion resistance and a longer service life of your suction excavator.
B30	ESE 4 ESE 6	Silence Kit	The Silence Kit's task is to noticeably reduce noise pollution. It combines the sound insulation package for the underside of the container and for the side walls behind the container lining with optimized soundproofing of the fan housing. The insulation layer is one and a half times the thickness of the standard material and is completely enclosed and insulated on the bottom. This noise reduction package is only available in conjunction with optional item M20 (side covering of the container).

## HOSE CARRIER

All RSP hose carriers come with proportional radio control gears that allow all the operations around service pipes, lines, cables etc. to be carried out in a non-destructive and very accurate manner. The swivel area is 180 degrees for all carriers. If in transport position, all hoses carriers are locked.

CODE	TYPE	VARIANT	DESIGNATION
C00	ESE 4	Telescopic hose carrier 3.500	The telescopic boom which covers a range of 3.50 m is flanged to the rear of the suction superstructure in the direction of travel on the pavement side. It is moved three-dimensionally via a hydraulically operated arm. Two steel wheels fitted at the end of the boom guide the suction hose into the vertical direction. A guard bow secures the hose in place during the suction operations. When the vehicle travels on the road, the telescoping boom rests in a retaining fork and the suction hose is secured with a rope.
	ESE 6		
C10	ESE 4	Extensions for the telescopic suction hose carrier 3.500	Slip-on extension with separate guide wheel, 1700 mm long. It expands the working range of the standard telescopic boom to 5.30 m. This extension can only be installed in conjunction with a hose extension D40.
	ESE 6		
C20	ESE 6	Telescopic hose carrier 6.600	The telescopic boom which covers a range of 6.60 m is flanged to the rear of the suction superstructure in the direction of travel on the pavement side. State-of-the-art PLC control, the use of prop valve technology assures sensitive adjustment of all speeds for moving the arm. It is moved three-dimensionally via a hydraulically operated arm. Two steel wheels fitted at the end of the boom guide the suction hose into the vertical direction. A guard bow secures the hose in place during the suction operations. For transportation, the hose is carried under the vehicle frame. This carrier needs a reinforced rear crosspiece and can only be fitted in conjunction with $\geq 8 \text{ m}^3$ collection tanks.



## HOSE CARRIER





CODE	TYPE	VARIANT	DESIGNATION
C30	ESE 4 ESE 6	Articulated hose carrier 4.100	The small version of the RSP articulated hose carrier has four joints and a range of 4.10 m. It is particularly suitable for superstructures having a width of 2.30 m
C40	ESE 6	Articulated hose carrier 6.000	Fully hydraulically operated articulated hose carrier with a 6 m range, 4 bends, securely guided up to the suction crown, very robust design. This model requires a reinforced rear crosspiece.







## WORKING AREA

The various holders allow you to safely transport the nozzle and hose extensions. They are mounted at the rear of the vehicle to ensure easy handling.

	CODE	TYPE	VARIANT	DESIGNATION
	D01	ESE 4 ESE 6	Suction nozzle extension	The steel suction inlet extension has a diameter of 250 mm and a length of 1230 mm. This hot dip galvanised extension inlet with the RSP clip system provides a very quick option for extending the working depth accordingly from 1.50 m to 2.30 m dependent on the hose carrier position. As this suction nozzle finds a use in almost all underground construction operations, its transportation lock is on the rear side of the vehicle.
	D11	ESE 4 ESE 6	Suction nozzle extension	This suction nozzle extension (dia.: 250 mm, length: 600 mm, hot-dip galvanized) is used whenever the last member of the hydraulic power arm make swivelling movements. The reduced length results in less force being applied to the junction zone. The suction inlet extension is hot dip galvanised and equipped with the RSP clip system.
	D21	ESE 4 ESE 6	Polyamide suction nozzle extension	The 250 mm diameter and 1230 mm long suction inlet extension is made of electrically insulating material so it can be used for work on buried electrical cables and in areas with high safety standards; it comes complete with the RSP clip system.

## WORKING AREA

The various nozzle and hose extensions offered by RSP allow you to easily and quickly extend the operating range.

	CODE	TYPE	VARIANT	DESIGNATION
	D31	ESE 4 ESE 6	Reducing extension	This 1,370 mm long extension reduces the diameter from 250 mm to 130 mm. It is used whenever the application involves operations around densely laid cables and lines where the standard size extension turns out to be too big. An adjustable air bypass enables the flow velocities resulting from the two cross sections to be adapted to each other in order to prevent the suction material from getting stuck. The reduction extension is hot dip galvanised and equipped with the RSP clip system.
	D41	ESE 4 ESE 6	PU suction hose extension	Dia.: 250 mm, length: 2,200 mm. It allows extending the operating range both in the vertical and in the horizontal direction. The coupling elements are hot dip galvanised and equipped with the RSP clip system.
	D42	ESE 4 ESE 6	PU suction hose extension with plastic coupling	Dia.: 250 mm, length: 2,200 mm. This light version of suction hose extension allows to increase operating range in vertical as well as horizontal direction. The coupling elements are made of plastic and equipped with Masterflex clips.
	D51	ESE 4 ESE 6	PU suction hose extension inclusive of a reducing adapter	This manually operated light-weight suction hose is 150 mm in diameter and 10 m long. It connects to the master suction hose via an adapter that reduces the diameter from 250 mm to 150 mm. An adjustable air bypass permits the regulation the velocity of the air in the master suction hose, complete with RSP clip system.

## WORKING AREA

Everything needs to be in its right place. Comfortably and functionally constructed holders keep the accessory parts in place on the machine.

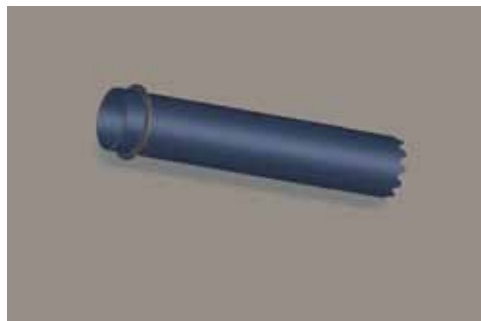

CODE	TYPE	VARIANT	DESIGNATION
D61	ESE 4 ESE 6	Suction nozzle extension, reinforced	Heavy-duty version of item D01 with a diameter of 250 mm and a length of 1230 mm, wall thickness 5 mm, complete with an RSP profile clip.
D62	ESE 4 ESE 6	Suction nozzle extension	Hop dip galvanised suction inlet extension with a diameter of 250 mm and a length of 1500 mm, complete with an RSP profile clip.
D63	ESE 4 ESE 6	Suction nozzle extension	Hop dip galvanised suction inlet extension with a diameter of 250 mm and a length of 2200 mm, complete with an RSP profile clip.
D70	ESE 4 ESE 6	Transport holder	The various clamps for connector or hose extensions ensure safe transport. Mounting on the rear of the vehicle ensures safe handling. The clamps are supplied galvanised.
D90	ESE 4 ESE 6	Masterflex clip	The Masterflex clip is very robust and easy to install. It is made from stainless steel and is suitable for the quick-release connection of metal connectors and conical flanges.
D91	ESE 4 ESE 6	RSP profile clip	The new clip ensures better load distribution and a stable connection between the individual components. It has a very robust design and offers long-term corrosion protection thanks to the galvanised system components. The smooth inner surfaces of the interlocking transitions of the components ensure reduced deposits during suction processes.

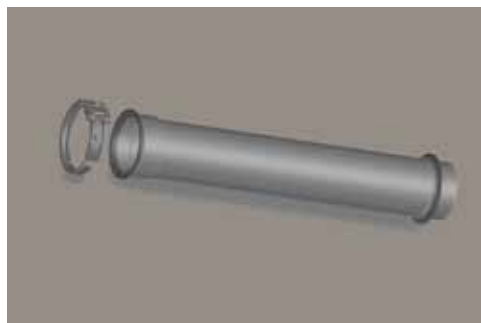

## HYDRAULIC SYSTEM

The hydraulic systems of all RSP suction superstructures consist of a hydraulic pump, pressure and return-line filter and oil reservoir. Electrically operated oil/air coolers produce the optimum temperature for operation. Pressure sensors allow the pressure to be controlled.

CODE	TYPE	VARIANT	DESIGNATION
E00	ESE 4 ESE 6	Hydraulic system	A robust pump which is flanged to the vehicle's PTO generates the necessary oil flow volume. The downstream pressure filters assure that only clean oil is pumped into the system – an important factor for the reliable operation of the proportional valves. The oil that flows back into the hydraulic fluid tank arranged on the side of the vehicle frame undergoes another cleaning process. An electric oil/air cooler keeps the oil temperature within narrow limits. This solution increases the service life and availability of the hydraulic system.
E10	ESE 4 ESE 6	By-pass fine-mesh filter	The by-pass fine-mesh filter ensures the optimum filtration of the hydraulic oil. Due to the very low flow rate per unit of time, the filters filter to 3 micrometers or lower, thereby achieving purity classes typical only for micro-hydraulic systems. An additional advantage is that even the finest water particles are filtered out. The purpose of this process is to prolong the service life of the overall system.
E20	ESE 4 ESE 6	Filling with biodecomposable oil	The hydraulic system can be filled with biologically decomposable oil. This oil has a substantially longer service life than other oil sorts and better viscosity behaviour at extreme temperatures. Your customer may require you to use this oil if the task involves operating around potable water lines.



## HYDRAULIC SYSTEM

It is of great advantage to install larger hydraulic cross sections since this causes a substantial reduction in the fluid flow velocity and has a positive influence on the life span of the entire hydraulic system.

CODE	TYPE	VARIANT	DESIGNATION
E30	ESE 4 ESE 6	Increased cooling capacity of the hydraulic system	Mounting an additional hydraulic oil cooler increases the cooling capacity which allows working at high ambient temperatures. Increased diameters of the hydraulic hoses are leading to lower flow velocity and thus better heat dissipation of the hydraulic oil. This has positive effects on the lifetime of the whole hydraulic system.
E41	ESE 4 ESE 6	External hydraulic outlet with switching valve	External hydraulic outlet on the rear of the vehicle to connect external consumers can be operated by radio remote control. DIN quick-acting closure coupling. (plug) Pressure line $P_{\max} = 160 \text{ bar}$ ; $Q_{\max} = 25 \text{ l/min}$ Functions „FORWARD“; „BACKWARD“ and „STOP“ (without load-holding function)
E42	ESE 4 ESE 6	Montage (no picture)	Installation of item E40 or E41 to the hose carrier





## PNEUMATIC SYSTEM

All RSP suction superstructures come with an autonomous compressed air system which can be activated separately. The air pressure is used to automatically clean the fine filters and to power the pneumatic tools.



CODE	TYPE	VARIANT	DESIGNATION
F00	ESE 4 ESE 6	Air connections	Compressed air outlets, 1x oiled air, 1x un-oiled air, to power the pneumatic tools can be found at the rear of the chassis. Another compressed air outlet inclusive of spiral hose and handheld gun can be found in the aggregate space.
F09	ESE 4 ESE 6	Compressor 3 m <sup>3</sup> /min, 7 bar	The standard compressor has an output volume of 3 m <sup>3</sup> /min at 7 bar. It features a hydraulic drive unit and a proportional suction intake regulator. The compressor oil is filtered in a separate filter element and undergoes temperature control. After the predetermined temperature threshold is reached, the oil cooler begins to operate. All incoming air is directed through a filter. The build-up of compressed air is used for the automatic filter cleaning. Air outlets provided at the rear of the vehicle permit pneumatically operated tools to be connected. An outlet to connect the hand-operated gun can be found at the compressor.
F 10 F 20	ESE 4 ESE 6	Compressor 3.6 m <sup>3</sup> /min oder 4.5 m <sup>3</sup> /min, 7 bar	In addition to the standard model (3 m <sup>3</sup> /min), RSP offers also compressors with higher power levels: 3.6 m <sup>3</sup> /min and 4.5 m <sup>3</sup> /min. This enables to operate several pneumatic tools at the same time.
F 30	ESE 4 ESE 6	Pneumatic vibrator on the container (no picture)	This pneumatic vibrator helps to empty the filter chamber almost completely and supports the automatic filter cleaning operation. Radio remote controlled.
F40	ESE 4 ESE 6	Hose reel for pneumatic hose	This hose reel with automatic spring return is mounted onto the rear side of the vehicle. The pneumatic hose is 8 m long and its diameter is 3/4 inch.



## WATER SYSTEM

Construction sites pose a real challenge for a machine. Contamination by dust, mud and dirt require a practical solution. The water system stands to clean the machine or spaces etc. at the construction site.



CODE	TYPE	VARIANT	DESIGNATION
G10	ESE 6	Water system 200 litres, pressurized water tank	The water system is effective in cleaning the machine and/or cleaning dirt etc. off operators. It comprises of a circa 200 ltr. reservoir which receives 3 bar pressurized air from the compressor. Filling and drain fittings as well as the overflow valve are accessible from outside. The tank has been approved by the German Technical Inspection Authority (TÜV). The scope further includes a 10 m water hose with spraying nozzle and filling valves.
G20	ESE 6	High-pressure water system inclusive of stainless steel hose reel	High-pressure water system, integrated into the suction excavator, 10 m high-pressure hose, handheld spray gun with pointed spray nozzle for loosening the soil, wide-angled spray nozzle for washing operations and vehicle care, filling and overflow valves, 10 m water hose for filling the tank, 60 micrometer water filter hydraulic drive ( $Q = 20 \text{ l/min}$ und $p = 210 \text{ bar}$ ), water pressure ca. 200 bar.



## WATER SYSTEM

The different tank variants and the possibility to combine the several tanks with each other provide for an even increased practical orientation. This really is the optimum solution: a sufficient amount of water for every use.



CODE	TYPE	VARIANT	DESIGNATION
G30	ESE 6 ESE 6	Pressure-free plastic water tank	The high-pressure water system employs larger pressure-free water reservoirs. Depending on the space available, such reservoirs are installed between driver cab and suction superstructure. The scope includes filling and overflow valves, filling level indicator and dry-running protection. The advantages of plastic water tanks include their elasticity in case of deformations.
G40	ESE 6 ESE 6	Customized special aluminium tank	This has been specifically designed by RSP. This tank is the appropriate solution if the space conditions prevent the use of plastic water tanks. Special baffle plates are fitted to their insides. The scope further includes filling and overflow fittings, level indicator, as well as dry-run protection.
G50	ESE 4 ESE 6 ESE 6	Waste water pump	This pump is driven by the vehicle's hydraulic system. It sucks excess water off the collection container or directly off the excavation pit. The flow rate is 1.200 l/min., and the maximum water pressure is 2 bar. Depending on the space available, the pump is installed on the side of the chassis frame. The delivery scope includes a hose that connects to the water outlet of the collection container.

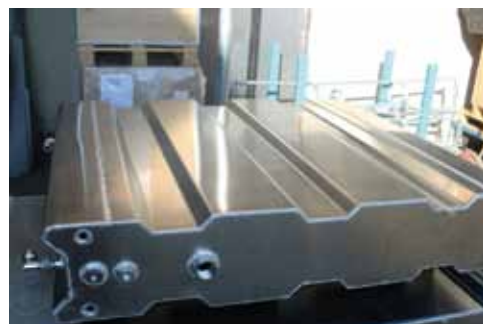

## CONTROL SYSTEM

The control system is the key to safe handling and user-friendliness. High-end components and expert installation are the basis for a long service life.

CODE	TYPE	VARIANT	DESIGNATION
H00	ESE 4 ESE 6	PLC control for the entire superstructure	The entire superstructure is monitored and controlled by a state-of-the-art PLC system. Information about the operating hours, number of revolutions, and temperatures are shown on the display, as well as error messages in case of a malfunction. Acoustic and visual signals remind you of service operations to be performed.
H01	ESE 4 ESE 6	SIM card	This telephone(data)card permits all operating states registered by the PLC control unit to be read and transferred. So you are able to objectively assess the causes of possible malfunctions and provide a targeted service. It also offers ex-works installation of program updates.
H02	ESE 4 ESE 6	Radio remote control of all superstructure functions	This feature enables you to operate the machine from an optimal location. It allows regulating all movements of the boom, the emptying & suction operations, the separate compressor operation, filter cleaning and travel motor start/stop. The hose carriers are proportionally and thus very accurately controlled from joysticks. A charging unit and a spare battery are installed in the driver's cabin. A spare transmitter of the same type is also included.



## CONTROL SYSTEM

Perfectly suited to meet the requirements of the industry

The specially developed control system is suitable for use in potentially explosive atmospheres up to zone 2.

CODE	TYPE	VARIANT	DESIGNATION
H10	ESE 4	Cable connection for the remote control box	A cable is used as the signal transmission line between radio transmitter and receiver. This equipment is necessary for operations where the use of radio frequencies is forbidden. Such locations include e.g. airports. The cable can only be connected to specially equipped radio control units
	ESE 6		
H20 H21 H22	ESE 4 ESE 6	Second radio transmitter, explosion-proof design	These radio transmitters are suitable for use in explosive atmospheres, suitable for explosion zone 2. Caution: special battery and special charger. To be operated like the standard radio remote control. (Code depending on the number of joysticks)
H30	ESE 4	Handheld emergency radio transmitter	This separate radio transmitter system allows turning off the vehicle in case of an emergency. This feature increases the level of work safety in the event that the operator stands not directly at the excavation site.
	ESE 6		
H31	ESE 4 ESE 6	Handheld emergency radio transmitter, explosion-proof	The handheld emergency radio transmitter is also available in an explosion-proof design. The same functions are available as in the above handheld emergency radio transmitter.





## ADDITIONAL EQUIPMENT

The additional components offered by RSP are designed to improve the handling of the machines. The spacious storage compartments with hinged lids provide space for all pieces of equipment necessary for the specific application.

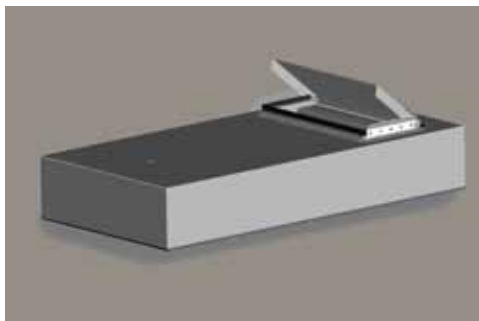
CODE	TYPE	VARIANT	DESIGNATION
100	ESE 4 ESE 6	RSP exhaust air silencer	The frequency-optimized exhaust air silencer consists of an aluminium housing with baffle silencers and sits within the machinery space. The exhaust air streams into the open via a flap secured with stop plates. As the air passes into the open in a vertical direction, the lowest possible level of nuisance to residents and passers-by is guaranteed.
101	ESE 4 ESE 6	Storage compartments	A spacious compartment (4 m long, 2 doors) involving an intermediate floor can be found underneath the tilting axis. The doors open to the top and are held in their end positions by means of gas springs. The interior surfaces are provided with an impact resistant stainless steel . Another compartment is provided in the container below the filters.
102	ESE 4 ESE 6	Operator safety equipment	Includes high visibility vest, hard hat, ear protection, safety goggles, work gloves
103	ESE 4 ESE 6	Electrical spare parts (no picture)	The package contains 1 x fuse 20A (master fuse), 1 x fuse 50A (oil cooler fuse) Fuses 5A, 10A, 15A, 30A,, 1 x each, 1 x relay 1 x voltage tester 24 V



## ADDITIONAL EQUIPMENT

	CODE	TYPE	VARIANT	DESIGNATION
	110 120	ESE 6	Hose rack <sup>(2)</sup>	Rack, same paint colour as the superstructure, located between driver cab and suction superstructure. It offers space for 2 x (4 x) hose extensions and has doors on the right and on the left so that the hoses can be taken out on each side. The space above the hoses can also be used for additional water tanks G10/G30/G40. The cladding is adapted to the height of the suction superstructure. The hoses shown on the picture are not included in the scope of delivery. The hoses shown on the picture are not included in the scope of delivery.
	130	ESE 6	Additional stainless steel storage box <sup>(2)</sup>	Sturdy storage box of stainless steel, mounted between front and rear axles depending on the space available. Stainless steel twist-lock catches. The lid can be opened downwards for easy loading and unloading.
	140	ESE 4 ESE 6	Tool box (no picture)	The RSP tool box contains an assortment of high-quality tools for minor maintenance and repair works.
	150	ESE 4 ESE 6	Hand-washing basin and soap dispenser	Hygienically clean hands are not only an obvious sign of personal care, but hand hygiene is the most important procedure to prevent diseases. Some occupational activities involve the handling of dirt, viruses, bacteria and hazardous substances and hands cannot always be washed at any desired time if the workplace is mobile and situated far away from stationary washrooms. The quick and practical solution for all construction site vehicles is this folding-type of hand-washing basin with a 5-litre reservoir of warm water. There are three chambers in the dispenser which are filled with soap, hand cream and disinfectant.

<sup>(2)</sup> Installation depends on the space available between the driver's cab and the suction superstructure.

## HYDRAULIC DRIVE UNITS

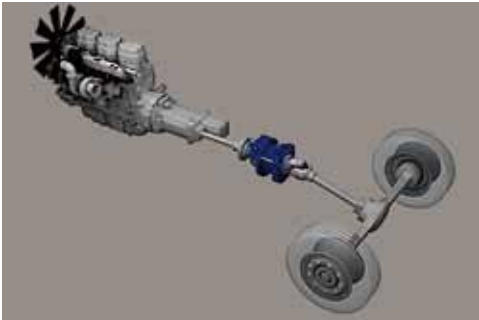

The hydraulic travel drive enables you to move the machine while it removes material. It is an especially useful tool for applications involving the removal of material over larger distances or from larger areas. RSP offers various possible implementation options. All functions are carried out by means of a joystick with safety control.

	CODE	TYPE	VARIANT	DESIGNATION
	J10	ESE 4 ESE 6	Reco Drive	Travel drive for vehicles with a short wheel base this solution implies that a half of a claw coupling is screwed into the travel cardan shaft on the intermediate support. The cardan shaft passes through the counterpart of said claw coupling to which a hydraulic gear motor is fitted. If said counterpart is shifted, the coupling closes while enabling the hydraulic gear motor to move the vehicle. Hydraulic fluid is supplied from the suction superstructure. This type of drive allows moving the vehicle forward and backward in a stepless manner in a range from 0 to 4 km/h provided it travels on even & low-gradient ground. Available only in conjunction with optional item F20
	J20 J21	ESE 4 ESE 6	RSP Drive	RSP Drive The hydraulically operated RSP travel drive is included into the drive train of the suction excavator chassis. It enables you to control the travel speeds for the slow forward and backward movements of the suction excavator while in operation. Speed range it 0 - 3 km/h. Available only in conjunction with optional item F20  As desired by the customer, the radial piston unit flanged into the drive train can work in an open hydraulic circuit (J20), (in case of occasional or short-term use), or in a closed hydraulic circuit (J21) (in case of frequent and long-term use) of the hydraulically operated RSP travel drive.





## HYDRAULIC DRIVE UNITS

The operator must very carefully check the road conditions before deciding to use the hydraulic travel drive with radio control. As the driver does not have the complete view of the road when the vehicle is steered from the rear, a road monitoring system is included in all RSP travel drives. This system turns off the travel drive as soon as the vehicle approaches an obstacle and applies the parking brake. The only thing the driver can do is to drive backwards with hydraulic support.

	CODE	TYPE	VARIANT	DESIGNATION
	J30	ESE 4 ESE 6	PCH Intermediate gear	This solution also uses an intermediate gear mounted into the travel gear cardan shaft. This gear offers an additional possibility, namely to transmit the rotary motion of the motor to a flange positioned above the cardan shaft entrance flange, which will then allow driving the ventilator. This gear has its own hydraulic pump which supplies fluid to the hydraulic motor that rotates the cardan drive leading to the rear axle. This type of drive allows moving the vehicle forward and backward in a stepless manner in a range from 0 to 6 km/h on inclines and slopes with a maximum gradient of 6%.
	J40	ESE 4 ESE 6	RSP Steering system	This external steering system has been specifically developed by RSP; its design does not necessitate the unauthorized use of the original steering components supplied by the chassis manufacturer. This external steering system is put onto the original steering wheel, secured in place and connected to the electrical system. The steering forces are applied in the same manner as in a manual steering operation. The steering system is operated via a joystick with safety function on the remote control box.
	J50	ESE 4 ESE 6	PCV	This intermediate gear serves to drive the fans in vehicles without a direct motor PTO. The power flow transferred from the cardan shaft to the rear axles is interrupted during operation and redirected to a top-mounted flange. A multi-plate clutch allows switching the PTO on and off.





## SAFTY EQUIPMENT / INDUSTRIAL EQUIPMENT

Prevention is the best protection. It is for this very reason that we offer a comprehensive safety package as standard. The modern and innovative safety equipment helps avoid accidents, recognise dangers and stay attentive.

	CODE	TYPE	VARIANT	DESIGNATION
	K00	ESE 4 ESE 6	Emergency stop button	All RSP suction superstructures come with emergency stop buttons on their rear end and on the remote control box. In case of danger, press the emergency stop button to shut off the entire superstructure inclusive of the drive motor. In addition to this, the suction air flow is interrupted immediately.
	K01	ESE 4 ESE 6	Sensors for the supports (no picture)	Proximity sensors serve to monitor the transport position of the supports. A visual signal appears in the driver's cab.
	K02	ESE 4 ESE 6	Slam shut valve	Demand-controlled fans only require approximately 60% of the drive power available. The fans in RSP's machines are controlled to the actual demand of intake air they need for starting. This eases the load on the drive train of the chassis vehicle and has a positive effect on fuel consumption. By activating the emergency stop button in case of danger, the air flow is interrupted immediately which is an important plus point on the work safety front.
	K03	ESE 4 ESE 6	Central lubrication system (no picture)	Central lubrication system, filled with special lubricant for all bearing points in RSP high-performance fans. This reduces the fan's daily maintenance requirements to a minimum. The standard PLC control unit provides continuous monitoring of fill level and operation. Visual and acoustic signals are emitted in case of a breakdown.
	K10	ESE 4 ESE 6	RSP video backward driving system	As soon as the driver goes into reverse, the high-quality reversing camera and the 7-inch colour monitor on the dashboard afford a view directly behind the vehicle. And as soon as he switches the monitor on by hand, he is afforded a view of the passing vehicles. The reversing camera is provided with a lotus-coated screen that protects it against stone impact, as well as with a temperature-controlled automatic heating for use under arduous operating conditions. No maintenance required.

## SAFETY EQUIPMENT / INDUSTRIAL EQUIPMENT

Increased safety for even safer operations especially in areas where high safety standards have to be met, e.g. in refineries, chemical plants and industrial plants where explosion risks exist.

	CODE	TYPE	VARIANT	DESIGNATION
	K20	ESE 4 ESE 6	Grounding system	All superstructure elements are connected by flexible earth lines. An earth cable is fed from the central ground point to an earth spike that was pounded into the ground using hand force. The quality of this ground connection is continuously monitored by an electronic device. Both proper and faulty operating conditions are visually displayed.
	K30	ESE 4 ESE 6	Gas detector system inclusive of 2 sensors	2 sensors measure the levels of gases (all combustible gases and hydrogen) in the intake air and in the ambient air on a continuous basis and send the information to the PLC. As soon as the pre-warning stage (20% of lower explosion limit) has been reached, both a visual and an acoustic signal are emitted. Once the main alarm is raised (40% of lower explosion limit), the vehicle is completely shut down. All inflammable gases are analysed, in particular methane, butane, propane and hexane. Every six months, the detection system has to undergo tests to check it for proper functioning. The scope of supply also includes a handheld measuring device and a charging station.
	K31	ESE 4 ESE 6	Safety package	The safety package comprises of the optional items K10 RSP video rear view system, K20 grounding system, K30 gas detection system, and K80 supports equipped with large-size plates.
	K40	ESE 4 ESE 6	Electrical filling level indicator	A radar system controls the filling level of the collection chamber. The result appears as a percentage figure on a display screen at the rear of the vehicle.
	K50	ESE 6	Axle load weighing system (no picture)	The weighing system is for vehicles with full air suspension. The air pressure value is converted into an analogue weight value, and the measuring accuracy is +/- 5%. Upon reaching the admissible overall weight, a signal is emitted, or the suction operation is stopped, as an option.

## SAFTY EQUIPMENT / INDUSTRIAL EQUIPMENT

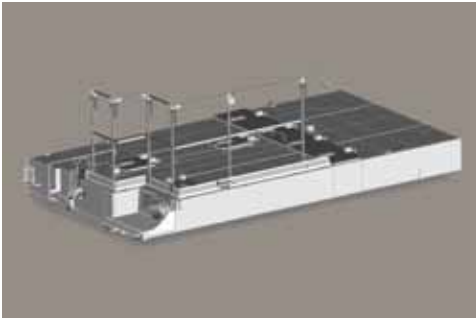
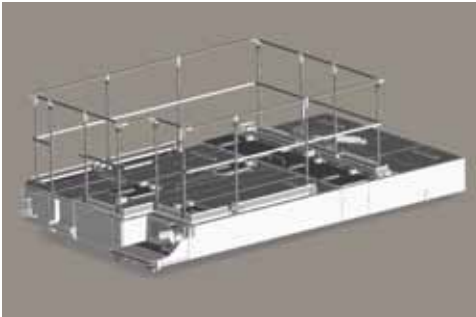
	CODE	TYPE	VARIANT	DESIGNATION
	K60	ESE 4	Handheld fire extinguisher with	This fire extinguisher is a 6 kg/12 kg powder fire extinguisher. It is installed in an easily accessible place on the vehicle
	K61	ESE 6	protective cabinet	
	K70	ESE 4 ESE 6	Corner safety railing	Safety-relevant component if it becomes necessary to climb onto the suction superstructure and for cleaning and maintenance works around the hose entrance point. Can be easily erected by hand.
	K71	ESE 4 ESE 6	Peripheral safety railing (no picture)	Safety-relevant component if it becomes necessary to climb onto the suction superstructure and for cleaning and maintenance works on the entire lid. Electrically-aided erection.
	K80	ESE 4 ESE 6	Supports with large pressure plates (no picture)	Not all industrial applications can be expected to offer solid ground conditions. These large pressure plates on the supports serve to improve the stability of the machine.
	K90	ESE 4 ESE 6	Additional super-structure supporting system at the rear	can be separately operated by remote control

## ILLUMINATING EQUIPMENT AND WARNING DEVICES

RSP attaches highest priority to safety. That is why we offer a wide range of additional illumination and warning devices that emit signals and/or illuminate the construction site.



CODE	TYPE	VARIANT	DESIGNATION
L00	ESE 4 ESE 6	Warning beacon	The warning beacon at the top of the vehicle rear alerts the road users already from a distance. This increases the operator safety on the road and during their operations.
L01	ESE 4 ESE 6	Halogen working light	The working light installed on the rear of the vehicle with free-form double reflector in modern design offers a considerably better illumination of the working area than a conventional working light. It comes with an incorporated vibration damping system, it can be tilted and swivelled and is thus the optimal solution for these applications.
L02	ESE 4 ESE 6	LED position lights	The LED position lights installed on the rear on the lid are coupled to the dipped-beam lamps. So, the vehicle's contours can be better seen in the dark.
L10	ESE 4 ESE 6	LED working lights	These LED working lights with their high-performance LEDs create a pleasant working light, similar to daylight conditions. As they are mounted to the suction hose carrier, they offer an optimum illumination of the working area.



## ILLUMINATING EQUIPMENT AND WARNING DEVICES

Further halogen or LED working lights are available in addition to the illumination and warning devices that come standard with the machine. RSP Light warning bar in modern design, or roof lamp bars that accommodate extra working lights and rotating beacon, for substantially increased safety on the construction site.



CODE	TYPE	VARIANT	DESIGNATION
L11	ESE 4 ESE 6	Magnetic base halogen working light	The magnetic base halogen working light emits a very bright light while also illuminating a broad area. This working light provides an optimal view and visibility. Its magnetic base and the 10 m cable from the cable drum make this working light a very versatile tool.
L20	ESE 4 ESE 6	LED Front flashing light Orange	Mounted to the radiator grill, it warns those road users and passers-by who – due to the vehicle height - face great difficulties to see the signal emitted by a roof bar. Highest quality for reliable and continuous operation, great warning effect on other road users, and operator self-protection on the road.
L21	ESE 4 ESE 6	Light package	The light package consists of four LED working lights (2 x optional item L10). In this package, the LED work light comes as a magnetic pedestal LED light, and the tool box is illuminated. With this feature you are optimally equipped for operations at night or in poorly areas.
L30	ESE 4 ESE 6	Light warning bar (picture below)	Modern-design RSP light warning bar, with or without illuminated centre part. The RSP light warning bars offer up to 20% more light volume. With its special mirror elements, a broader radiation spectrum and placement on the roof you will be better seen at an earlier point in time. This increases the operator safety on the road and during their operations.
L31	ESE 4 ESE 6	LED Light warning bar (no picture)	Modern-design LED light warning bar, clear-glass look. The light warning bar includes four high-performance LED modules and additional mirrors for a brighter light, and a centre part illuminated in white. Due to the roof-top placement, it alerts the other road users already from a distance. This increases the operator safety on the road and during their operations.
L40	ESE 4 ESE 6	RSP roof lamp bar Jumbo	The extra working lights on the roof bar make the journey to the construction sites easier at night. The roof bar is also a distinct design element on the front of the vehicle.
L50	ESE 4 ESE 6	Retro-reflective marking on the vehicle	The fitment of contour line markings on commercial road vehicles is a cost-effective self-protection measure. Not only do these markings improve the visibility of your vehicle and allow better estimation of vehicle speed or distance to other vehicles, they really enhance your vehicle's appearance and also the image of your company.

## DESIGN

A high-quality RSP suction excavator turns into a customized machine. The complex cladding emphasizes the very specific character of your suction excavator and its sophisticated functionality.





CODE	TYPE	VARIANT	DESIGNATION
M00	ESE 4 ESE 6	Superstructure coated with high-gloss paint	In our painting facility the superstructure receives the two-component RAL colour coating desired by the customer. Prior to painting, all parts are sandblasted, subjected to a degreasing treatment in our modern phosphating unit, and finally primed.
M01	ESE 4 ESE 6	Superstructure coated with texture paint for construction machines (no picture)	This paint is considerably less sensitive and thus more durable than gloss paint. The paint is silk matt. Marketing decals cannot be affixed to such surfaces.
M10	ESE 4 ESE 6	Chosen paints (no picture)	It is also possible to paint your vehicle in a metallic coloured paint, or apply a coat of clear varnish.
M20	ESE 4 ESE 6	Cladding on the side of the collection container	These are aluminium plates, painted in the colour of the superstructure. The covered parts are also provided with a finish paint-coating. Large advertising space is created. Another advantage: makes vehicle cleaning easier.
M30	ESE 4 ESE 6	Cladding on the side between superstructure and cabin	Depending on the vehicle type, wheelbase etc. the spaces created between the chassis cabin and the suction superstructure may vary in size etc. If the clearance is more than 30 cm, M20 will significantly improve the overall visual look of the machine. The cladding consists of aluminium plates, painted in the colour of the superstructure, and adapted to fit the geometrical conditions.
M40	ESE 4 ESE 6	Individual labelling with Corporate Identity Elements	In order for you to be able to start the work with your new machine as soon as possible, we affix all your individual labels etc. to the excavator. Simply supply the data/drafts, and we will make you an offer.

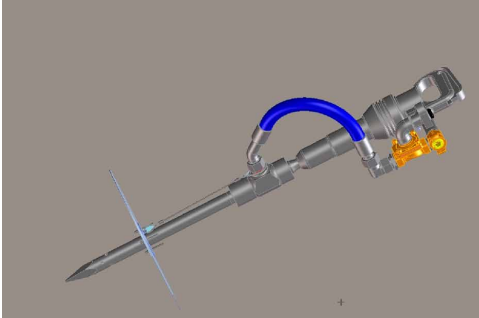

## EQUIPMENT FOR LOOSENING THE GROUND

Equipment for loosening the soil especially developed for use on construction sites makes work in hard or compacted ground much easier. The exactly controlled blasts of compressed air are perfectly suited for search and unearthing operations around underground service pipes, ducts, cables, etc.

	CODE	TYPE	VARIANT	DESIGNATION
	N10	ESE 4 ESE 6	Pneumatic blowing lance	The insulated blowing lance blasts large volumes of air into the ground at specific points, thereby loosening even the hardest soil. However, the soft air does not inflict damage to lines, cables, etc. which makes this tool particularly suitable for ground searching and uncovering operations around supply lines. This lance proves its worth as an effective tool even in hard to reach areas, narrow ditches, areas involving crossing lines, and operations in the area around tree roots.
	N20	ESE 4 ESE 6	Pneumatic blowing lance	The insulated blowing lance blasts large volumes of air into the ground at specific points, thereby loosening even the hardest soil. However, the soft air does not inflict damage to lines, cables, etc. which makes this tool particularly suitable for ground searching and uncovering operations around supply lines. This lance proves its worth as an effective tool even in hard to reach areas, narrow ditches, areas involving crossing lines, and operations in the area around tree roots.
	N30	ESE 4 ESE 6	Pneumatic blowing lance 2.000	This is a robust steel tube, 2 m long, with a special air outlet orifice and a slide valve. It allows loosening the soil and blowing material out of the construction pit from a place outside the pit.
	N31	ESE 4 ESE 6	Pneumatic blowing lance	Blowing lance, specifically developed by RSP for use around live electric cables. Certification for a dielectric strength of 50 kv.



## EQUIPMENT FOR LOOSENING THE GROUND

The pneumatic hammer is an indispensable tool if the task includes earth-breaking operations on construction sites. Depending upon soil consistency, the hammer operates in a fast and efficient manner to uncover the damaged spots.



CODE	TYPE	VARIANT	DESIGNATION
N40 N41	ESE 4 ESE 6	Pneumatic hammer 9 kg/21 kg (no picture)	The pneumatic hammer is an indispensable tool if it comes to soil breaking operations at construction sites. Thanks to an optimum power-to-weight ratio, sound attenuation and vibration damping features and an ergonomic handle it is easy to work with. The scope of delivery includes a spade blade and a pointed chisel. Available versions include 9 kg and 21 kg.
N50	ESE 4	Pneumatic spade	This spade has a release mechanism on the side. It has a 115 mm wide spade, presents good percussive action and its design complies with the principles of ergonomics.
	ESE 6	11 kg (no picture)	
N60	ESE 4 ESE 6	Special pneumatic spade	This tool relieves of strenuous physical work. The spade eases the work considerably, particularly in narrow excavation pits.
N70	ESE 4	Pneumatic	1" flat hoses, intended to connect machinery for loosening the soil.
	ESE 6	connection lines	
N80	ESE 4	Additional	The scope of delivery comprises of Hand-operated spade with 2 m long handle, Scraping/pulling device, hot-dip galvanized, Pipe cleaner, half-round, hot dip galvanized, Pinch bar, Grease gun, Rubber hammer, Oil discharge hose.
	ESE 6	hand-operated tools	



## MACHINE HAND-OVER / TRAINING

Machine handover to the customer and training courses are administered in our in-house delivery center. Here, the customers can take over the machines in a relaxed atmosphere. The customer also receives 2 copies of the machine documentation, thereof one copy on a CD.



CODE	VARIANT	DESIGNATION
O00	Training	The machine is handed over to the customer in the cosy setting of our in-house delivery facility. This is also the place where our experienced staff members give comprehensive instruction on how the machine functions, how it is operated and maintained.
O01	Documentation	Together with the machine, the hard-copy documentation in your national language is handed over to you. Apart from detailed operating instructions, said documentation comprises the hydraulics plan, pneumatic and circuit diagrams, as well as CE documents and data sheets.
O02	Access to the RSP online catalogue	Your access to the RSP online catalogue is enabled as soon as you take ownership of the machine. This catalogue contains all of the documents relating to your machine as well as a list showing all of the spare parts and accessories which are readily available to order immediately if required.
O10	Technical approval	All RSP suction superstructures are subjected to individual tests to obtain the approval from the competent inspection agency. The brakes of the vehicles are adjusted in accordance with the guidelines from the vehicle manufacturers. The corresponding documents form a part of the machine documentation. Upon delivery, the tank of the vehicle is filled with a fuel volume of max. 300 l.
O20	Temporary registration plate	Five-day license plate, inclusive of comprehensive own-damage insurance for transporting the machine.
O21	Export registration plate 1 month	A registration plate inclusive of insurance against civil liability is valid for 1 month, for transfer the machine. Proof of the existence of a comprehensive own-damage motor insurance has to be furnished prior to transfer the machine.
O31	Formalities	Additional customs formalities have to be satisfied in the event of delivery of goods to countries outside the EU. We handle the complete process for you, starting with the customs export declaration and going right through to preparing the supplier's declaration and all the other documents required.

## VEHICLE CHASSIS

Our suction superstructures can be mounted onto carrying chassis from all chassis manufacturers. We would be pleased to advise you in finding the chassis type that best suits the requirements of your applications.

CODE	TYPE	VARIANT	DESIGNATION
P00	ESE 4 ESE 6	Delivered by the customer	The customer delivers the chassis „free to our factory in Saalfeld“, ca. 6 to 8 weeks before the confirmed delivery date. The chassis specification must have been approved by RSP. If extra work is to be carried out on the chassis, RSP will notify the customer thereof after a technical examination; all such extra work is to be paid for separately by the customer.
P10	ESE 4 ESE 6	Delivered by RSP	Provision of the vehicle chassis by RSP GmbH. We would be happy to provide you with an offer including all necessary specifications.

## CHASSIS FEATURES REALIZED BY RSP

Our construction department examines your chassis to find out whether or not the chassis needs to be modified to accommodate the desired machine configuration.

CODE	TYPE	VARIANT	DESIGNATION
Q10	ESE 4 ESE 6	under-run guard on the side	Installation of the under-run guard on the side for vehicles that are not fitted with an under-run guard as standard.
Q11	ESE 4 ESE 6	under-run guard at the rear	Installation of the under-run guard at the rear for vehicles that are not fitted with an under-run guard as standard.
Q12	ESE 4 ESE 6	Extension of the frame	Extension of the frame overhang for vehicles without sufficient overhang.
Q20	ESE 4 ESE 6	Relocation of the battery box	If the result of the technical examination shows that the battery box might collide with components of the suction superstructure, it is necessary to relocate the battery box by more than 50 mm.
Q21	ESE 4 ESE 6	Installation of a stacked battery	In chassis with a very short wheelbase
Q30	ESE 4 ESE 6	Reconstruction Diesel tank	If the result of the technical examination shows that the diesel tank might collide with components of the suction superstructure, it is necessary to modify the tank.

## CHASSIS FEATURES REALIZED BY RSP

CODE	TYPE	VARIANT	DESIGNATION
Q40	ESE 4 ESE 6	Installation of the fenders	per axle for vehicles that are not fitted with fenders as standard
Q50	ESE 4 ESE 6	Bi-Carburations-System	In certain countries, the suction excavator may operate (not travel) on cheap fuel oil. The bicarburation system allows operating with fuel from either the travel or the operations tank.
Q51	ESE 4 ESE 6	Additional fuel tank	Installation and commissioning of an additional diesel tank (also without Q 50 bi-carburation system)
Q60	ESE 4 ESE 6	Reconstruction power steering pump	Necessary for different chassis with a wheelbase
Q70	ESE 4 ESE 6	Reconstruction four-circuit protection valve	If the result of the technical examination shows that the elements might collide with components of the suction superstructure, it becomes necessary to modify the four-circuit protection valve, the compressed air reservoir and the compressed air drier.
Q80	ESE 4 ESE 6	Fitting of an additional gear box holder	necessary only at some different chassis

## EQUIPMENT

### NOTES

NOTES

Blank lined area for notes, consisting of seven horizontal gray bars.



[www.rsp-germany.com](http://www.rsp-germany.com)

Reschwitzer Saugbagger Produktions GmbH  
Zum Silberstollen 10 - 07318 Saalfeld, Germany  
Telefon +49 3671 57 21 0 Fax +49 3671 57 21 21

Not all products are available in all markets. Under our policy of continuous improvement, we reserve the right to change specifications and design without prior notice. The illustrations do not necessarily show the standard version of the machine.  
English 2016/06